

5-Port Solar PoE Switch with 1-Port 1000X SFP

BSP-115 Series

User's Manual

Table of Contents

1. Package Contents	3
1.1 Packet Contents.....	4
1.2 Product Description	4
1.3 Product Features.....	8
1.4 Product Specifications.....	11
2. Hardware Introduction	16
2.1 BSP-115HP-5A.....	16
2.1.1 BSP-115HP-5A Front Panel.....	16
2.1.2 BSP-115HP-5A Rear Panel.....	17
2.1.3 BSP-115HP-5A LED Definition.....	19
2.2 BSP-115PV-15A	22
2.2.1 BSP-115PV-15A Front Panel	22
2.2.2 BSP-115PV-15A Rear Panel	23
2.2.3 BSP-115PV-15A LED Definition:	25
2.3 Wiring the Power Inputs.....	28
2.4 Grounding the Device.....	30
3. Installation.....	31
3.1 Wall-mount Plate Mounting	31
3.2 Hardware Installation	32
3.3 Installing the Solar PoE Switch.....	32
3.4 Installing Battery	32
3.5 Installing PV Panel	34
3.6 Installing DC Power.....	35
4. Smart LCD Screen Description	36
4.1 Smart LCD screen description (BSP-115PV-15A only):.....	36
5. Customer Support	38
Appendix A: Recommended Use of the Connected Wires.....	39

1. Package Contents

Thank you for purchasing PLANET **BSP-115HP-5A** and **BSP-115PV-15A Solar PoE Switches**. The descriptions of this **BSP-115** series are as follows:

BSP-115HP-5A	5-Port Hybrid PoE Solar PoE Switch with 1-Port 1000X SFP
BSP-115PV-15A	5-Port 802.3at PoE+ Solar PoE Switch with 1-Port 1000X SFP and LCD Display





The hardware specifications of these models are shown below:

Model Name \ Item	10/100/1000T RJ45 Ports	100/1GX SFP Slots	PoE Ports	LCD	Power Input
BSP-115HP-5A	5	1	5	--	PV/DC/BAT
BSP-115PV-15A	5	1	5	1.1-inch	PV/BAT

In the following sections, the term **"Solar PoE Switch"** refers to the BSP-115HP-5A or BSP-115PV-15A.

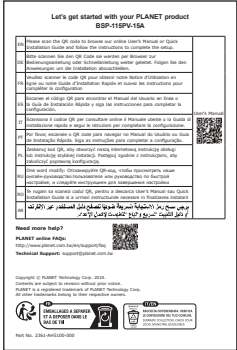
1.1 Packet Contents

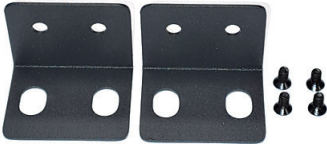
Open the box of the Solar PoE Switch and carefully unpack it. The box should contain the following items:

Solar PoE Switch x 1	QR Code Sheet x 1	Temperature sensor x1
		
Wall-mount Kit x 1	SFP Dust Cap x 1	Screwdriver x 1
		

If any of these are missing or damaged, please contact your dealer immediately; if possible, retain the carton including the original packing material, and use them again to repack the product in case there is a need to return it to us for repair.

1.2 Product Description

Industry-leading Integration of PoE Technology and Renewable Power System

PLANET's newly-launched Renewable Energy Industrial PoE Ethernet Switch, the BSP-115 Series, can be charged by the inexhaustible and natural source of energy, such as solar, wind and hydroelectric power to conserve energy so as to economically power these remote IP cameras and wireless APs.

The BSP-115 Series is equipped with 5 10/100/1000BASE-T copper ports supporting PoE injector function, a total PoE power budget of up to 65/120 watts and 1 extra 100/1000BASE-X SFP fiber port especially used for such expansive applications as dams, forests, deserts, national parks, nature/animal protection areas and

highways. It is designed to efficiently handle power distribution for a versatile array of connected devices which meet the Environmental, Social, and Governance (ESG) principles. Leveraging cutting-edge IP-based technology, PLANET has transformed conventional Power Over Ethernet (PoE) into genuine networking devices that align with sustainable and responsible business practices.

BSP-115HP-5A (65W) Front Panel

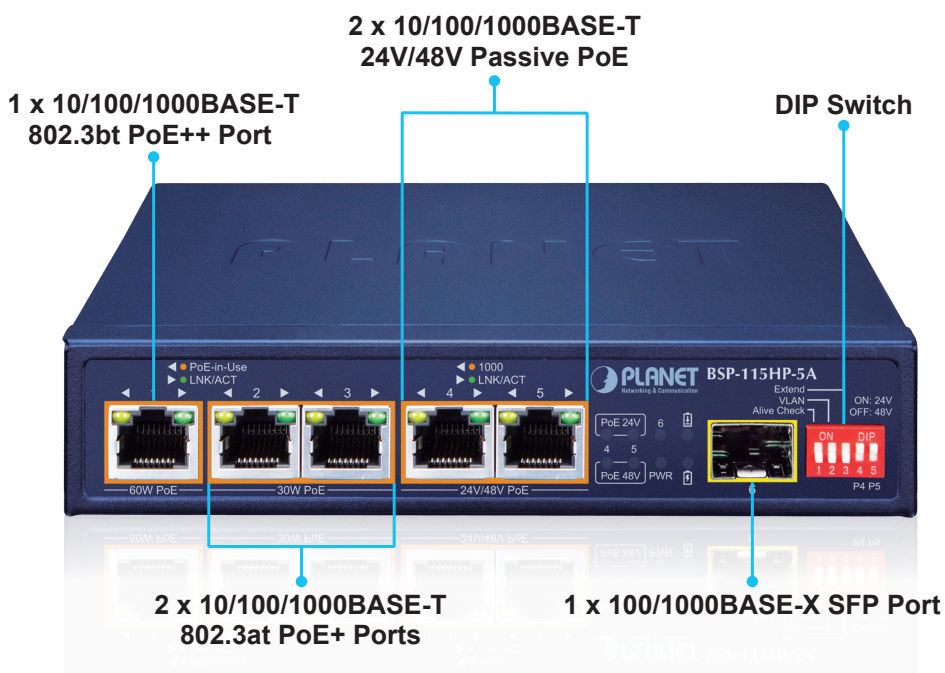

BSP-115HP-5A (65W) Rear Panel

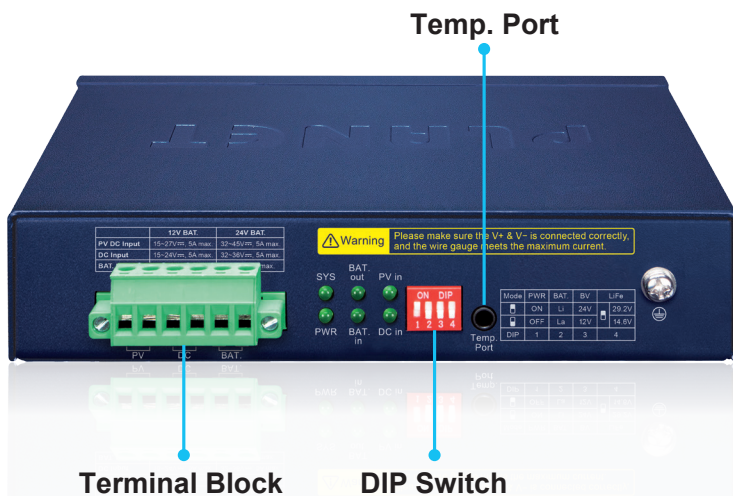

BSP-115PV-15A (120W) Front Panel

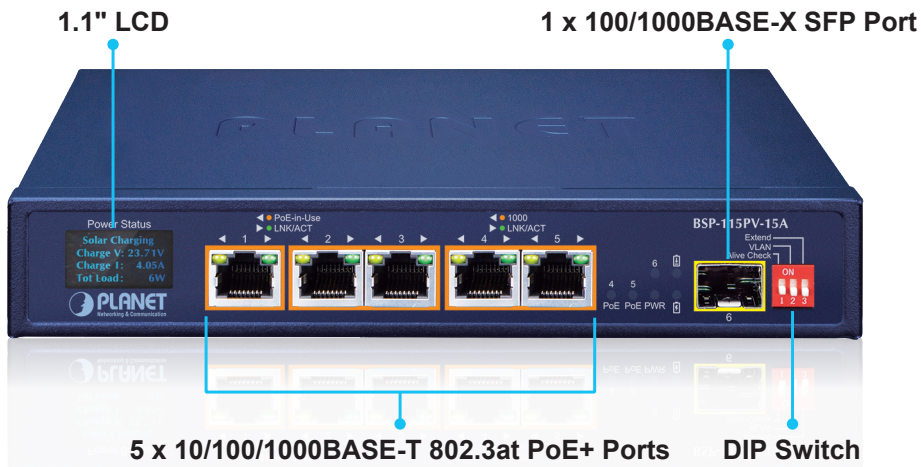

BSP-115PV-15A (120W) Rear Panel

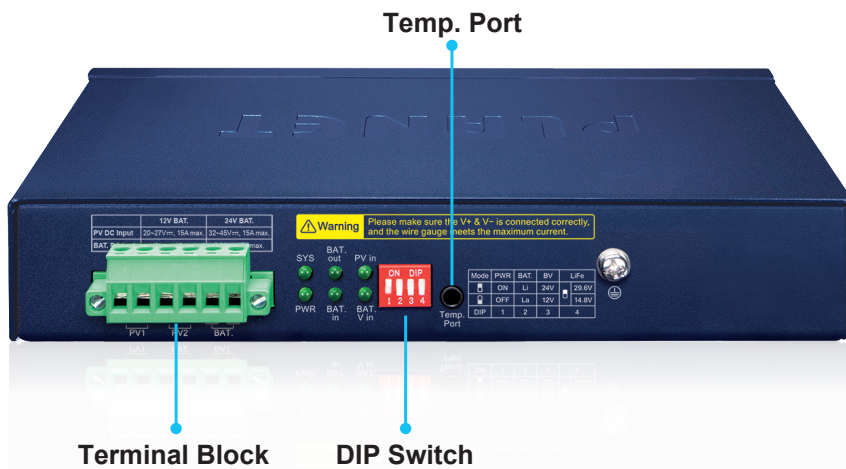

Zero-Carbon and Stable Power Supply

The 12V/24V lithium, lead-acid or lithium iron battery gets recharged by way of the BSP-115 Series where solar power is sourced. Thus, the BSP-115 Series will keep powering PDs without the need of any power cabling. Its zero-carbon feature is made possible as the energy the unit gets is renewable. Most importantly, the operation of outdoor wireless IP-based surveillance can be continued into the night as the battery is charged during the day.

Multi-functional Solar PoE Switch that Supports PV, DC, and Battery Simultaneously

The Solar PoE Switch is a versatile device that supports simultaneous applications of solar (PV), DC (For BSP-115HP-5A only), and battery power. Utilizing advanced solar charging control technology, even the voltage is different from DC input. It efficiently converts solar energy into power and provides stable and reliable DC power supply. It is ideal for applications requiring eco-friendly and energy-efficient solutions, such as remote communication base stations, surveillance systems, and network cameras. Its flexible design not only reduces operational costs but also diminishes reliance on traditional energy sources, thereby reducing environmental impact. The Solar PoE Switch represents not just technological innovation but also a substantial contribution to sustainable development, offering the applications a more stable and dependable energy solution.

Smart Battery Management

The BSP-115 Series features the following special power management functions:

- Current battery usage status by percentage
- Over budget PoE port disconnection protection (port 5)

Smart and Intuitive LCD Monitoring

(For BSP-115PV-15A only)

As the front panel of the BSP-115PV-15A provides an intuitive panel, the current solar energy and battery statuses can be checked on the BSP-115PV-15A LCD screen. This easy operation can enhance the energy management efficiency of renewable PoE switches as the following special status functions are included:

- Displays solar input voltage and current power
- Displays battery voltage and current power
- Displays PoE current power
- Displays battery remaining charging time
- Shows battery remaining time

Intelligent Powered Device Alive Check

The BSP-115 Series can monitor connected PD status in real time via PD alive check function. Once the PD stops working and responding, the BSP-115 Series will resume the PoE power and bring the PD back to work. It will greatly enhance the network reliability through the PoE port resetting the PD's power source and reducing administrator management burden.

802.3at PoE+ Power and Ethernet Data Transmission Distance Extension

Its DIP switch can set the system to extend mode. In addition, the BSP-115 Series is equipped with VLAN technology and operates on a per-port basis at 10Mbps duplex operation. It can also support 21.2-watt PoE power output over a distance of up to 250 meters overcoming the 100m limit on Ethernet UTP cable.

With this brand-new feature, the BSP-115 series provides an additional solution for 802.3at/af PoE distance extension, thus saving the cost of Ethernet cable installation.

Multiple Battery Options for All Market Requirements

The BSP-115 Series features a variety of battery options, including lead-acid, lithium, and lithium iron batteries. Lead-acid battery offers a cost-effective option while lithium battery offers higher energy density and lightweight design, and lithium-iron battery combines high energy efficiency with durability. The renewable PoE switch provides a flexible, reliable solution that ensures all applications can continue to run without a glitch.

1.3 Product Features

Physical Port

- Five 10/100/1000BASE-T Gigabit RJ45 copper ports
- One 100/1000BASE-X SFP slot for SFP type auto detection

Power over Ethernet

- Port 1 supports 802.3bt 60-watt PoE++ injector function (For BSP-115HP-5A)
- Ports 2 to 3 support 802.3af/at 35-watt PoE+ injector function (For BSP-115HP-5A)
- Ports 4 to 5 support 24V (passive)/48V (af/at) PoE+ injector function (For BSP-115HP-5A)
- Up to 5 ports of IEEE 802.3af/802.3at/802.3bt devices powered (For BSP-115HP-5A)
- 65-watt PoE budget (For BSP-115HP-5A)
- Up to 5 ports of IEEE 802.3af/802.3at devices powered (For BSP-115PV-15A)
- Supports PoE power up to 35 watts for each PoE port (For BSP-115PV-15A)
- 120-watt PoE budget (For BSP-115PV-15A)
- Complies with IEEE 802.3at Power over Ethernet Plus end-span PSE

- Backward compatible with IEEE 802.3af Power over Ethernet
- Auto detects powered device (PD)
- Circuit protection prevents power interference between ports
- Remote power feeding up to 250 meters
- PoE management
 - Total PoE power budget control
 - PD alive check

Smart LCD (For BSP-115PV-15A only)

- Displays solar input voltage and current power
- Displays battery voltage and current power
- Displays PoE current power
- Displays battery remaining charging time
- Shows battery remaining time

Battery Management

- Battery type option: Lithium battery, lithium iron battery or lead-acid battery
- Easy diagnostic of the system operating status via LED indicator
- Current battery usage status
- Maximum Power Point Tracking Charge Controller (For BSP-115PV-15A)
 - Reverse current protection to prevent the current circuits from flowing back to the PV panel
 - Over-current protection
 - Reverse polarity protection (for battery and charging electrodes)

Case and Installation

- IP30 metal case
- Desktop and wall-mount designs
- Supports -20 to 65 degrees C operating temperature
- Supports ESD 4KV contact and 8KV air DC Ethernet protection
- Supports surge protection up to 2KV

Power Requirements

- Supports 12V solar panel input (open circuit voltage = 27V) with 12V battery
- Supports 24V solar panel input (open circuit voltage = 45V) with 24V battery
- PV DC input, 12V battery pack -- DC input range 20-27V, maximum input power 405W
- PV DC input, 24V battery pack -- DC input range 32-45V, maximum input power 675W
- Supports 15~24V DC input with 12V battery (For BSP-115HP-5A)
- Supports 32~36V DC input with 24V battery (For BSP-115HP-5A)

Switching

- Hardware-based 10/100Mbps (half/full duplex), 1000Mbps (full duplex), auto-negotiation and auto MDI/MDI-X
- Features Store-and-Forward mode with wire-speed filtering and forwarding rates
- IEEE 802.3x flow control for full duplex operation and back pressure for half duplex operation
- 2K MAC address table size
- 10K jumbo frame
- SFP slot supports dual speed, 100BASE-FX and 1000BASE-SX/LX SFP (Small Form-factor Pluggable) fiber-optic modules.

The distance can be extended to 2km (multi-mode fiber) and to 120 kilometers (single-mode fiber or WDM fiber).

1.4 Product Specifications

Product	BSP-115HP-5A	BSP-115PV-15A
Hardware Specifications		
Copper Ports	5 10/100/1000BASE-T RJ45 auto-MDI/MDI-X ports	
SFP Port	1 100/1000BASE-X SFP port	
Connector	Removable 6-pin terminal block Pin 1/2(+/-) for PV panel Pin 3/4(+/-) for DC power Pin 5/6(-/+) for battery charging and discharging	Removable 6-pin terminal block Pin 1/2(+/-), 3/4(+/-) for PV panel (in parallel); Pin 5/6(-/+) for battery charging and discharging The PV input is compliant with DC input but cannot be connected simultaneously with solar input to prevent damage to the device.
DIP Switch	Front Panel: <ul style="list-style-type: none"> ■ Alive Check: All PoE ports enable PD Alive check function. ■ VLAN: Port isolation ■ Extend: Long distance PoE switch. ■ P4: PoE 24V/48V switch ■ P5: PoE 24V/48V switch 	Front Panel: <ul style="list-style-type: none"> ■ Alive Check: All PoE ports enable PD Alive check function. ■ VLAN: Port isolation ■ Extend: Long distance PoE switch.
	Rear Panel: <ul style="list-style-type: none"> ■ PWR: Equipment power switch ■ BAT: Battery type switch ■ BV: Battery voltage switch ■ LiFe: Lithium iron phosphate switch 	Rear Panel: <ul style="list-style-type: none"> ■ PWR: Equipment power switch ■ BAT: Battery type switch ■ BV: Battery voltage switch ■ LiFe: Lithium iron phosphate switch

<p>Power Requirements</p>	<p>Supports 12V solar panel input (open circuit voltage = 27V) with 12V battery</p> <p>Supports 24V solar panel input (open circuit voltage = 45V) with 24V battery</p> <p>Compatible with DC input, 12V battery pack: DC input range DC 15-27v, maximum input power 135W;</p> <p>Compatible with DC input, 24V battery pack: DC input range DC 32-45v, maximum input power 225W;</p> <p>Supports 15~24V DC input with 12V battery</p> <p>Supports 32~36V DC input with 24V battery</p>	<p>Supports 12V solar panel input (open circuit voltage = 27V) with 12V battery</p> <p>Supports 24V solar panel input (open circuit voltage = 45V) with 24V battery</p> <p>Compatible with DC input, 12V battery pack: DC input range DC 20-27v, maximum input power 405W;</p> <p>Compatible with DC input, 24V battery pack: DC input range 32-45v, maximum input power 675W;</p>
<p>Charging Function</p>	<p>Integrated automatic charging and discharging, maximum efficiency 98%, maximum charging current 5A</p> <p>Integrated battery protection function</p> <p>Integrated battery float charging function</p> <p>Supports over-temperature protection function</p>	<p>Integrated automatic charging and discharging, maximum efficiency 98%, maximum charging current 15A</p> <p>Integrated battery protection function</p> <p>Integrated battery float charging function</p> <p>Supports over-temperature protection function</p>
<p>Battery Type</p>	<p>Based on Full Loading power consumption:</p> <ul style="list-style-type: none"> ■ 12V/24V lead-acid battery, maximum charging current 5A ■ 12.6V/25.2V lithium battery, maximum charging current 5A ■ 14.6V/29.2V lithium iron battery, maximum charging current 5A <p>Note: Recommended capacity 290AH in full power 65W usage</p>	<p>Based on Full Loading power consumption:</p> <ul style="list-style-type: none"> ■ 12V/24V lead-acid battery, maximum charging current 15A ■ 12.6V/25.2V lithium battery, maximum charging current 15A ■ 14.6V/29.2V lithium iron battery, maximum charging current 15A <p>Note: Recommended capacity 500AH in full power 120W usage</p>

Power Consumption/ Dissipation	3.36 watts, 11.5BTU (Standby without PoE function) 75.6 watts, 257.8 BTU (Full loading with PoE function)	3 watts, 10.2BTU (Standby without PoE function) 140 watts, 477 BTU (Full loading with PoE function)
Dimensions (W x D x H)	142 x 159 x 34 mm	142 x197 x 34mm
Weight	690g	820g
LCD Monitor (W x D)	--	26.77 x 16 mm, 1.1-inch
Temperature Sensor	Temperature Detect -20 ~ 100 Degree C	Temperature Detect -20 ~ 120 Degree C Humidity Detect 0 ~ 100 % RH
Humidity Detect 0 ~ 100 % RH	±8KV air gap discharge ±4KV contact discharge	
Surge Immunity	2KV	
Enclosure	IP30 metal case	
Installation	Desktop/Wall-mount ear	
Fan	Fanless design	
LED Indicators	<p>Front Panel:</p> <p>System:</p> <ul style="list-style-type: none"> - Green: PWR, ↓ BAT. out, ⚡ BAT. in <p>Per 10/100/1000T RJ45 Port: (Port 1~Port 3):</p> <ul style="list-style-type: none"> - Green: LNK/ACT (10/100/1000Mbps) - Amber: PoE-in-use <p>Per 10/100/1000T RJ45 Port: (Port 4~Port 5):</p> <ul style="list-style-type: none"> - Green: LNK/ACT (10/100Mbps) - Amber: 1000Mbps - Green: 24V PoE-in-use - Green: 48V PoE-in-use <p>Per SFP Port: (Port 6):</p> <ul style="list-style-type: none"> - Green: LNK/ACT (100/1000Mbps) 	<p>Front Panel:</p> <p>System:</p> <ul style="list-style-type: none"> - Green: PWR, ↓ BAT. out, ⚡ BAT. in <p>Per 10/100/1000T RJ45 Port: (Port 1~Port 3):</p> <ul style="list-style-type: none"> - Green: LNK/ACT (10/100/1000Mbps) - Amber: PoE-in-use <p>Per 10/100/1000T RJ45 Port: (Port 4~Port 5):</p> <ul style="list-style-type: none"> - Green: LNK/ACT (10/100Mbps) - Amber: 1000Mbps - Green: PoE-in-use <p>Per SFP Port: (Port 6):</p> <ul style="list-style-type: none"> - Green: LNK/ACT (100/1000Mbps)

LED Indicators	Rear Panel: System: - Green: SYS, PWR, PV in Battery: - Green: BAT. out, BAT. in, DC in	Rear Panel: System: - Green: SYS, PWR, PV in Battery: - Green: BAT. out, BAT. in, BAT. V in
Switching Specifications		
Switch Architecture	Store-and-Forward	
Switch Fabric	12Gbps/non-blocking	
Switch Throughput	8.92Mpps@64 bytes	
MAC Address Table	2K entries	
Shared Data Buffer	2.5Mb	
Jumbo Frame	10K bytes	
Power over Ethernet		
PoE Standard	IEEE 802.3af/802.3at/802.3bt Power over Ethernet PSE	IEEE 802.3af/802.3at Power over Ethernet PSE
PoE Power Supply Type	End-span	End-span
PoE Power Output	Port 1 48V DC, max. 60 watts Port 2-3 48V DC, max. 35 watts Port 4-5 24V DC, max. 25 watts or 48V DC, max. 35 watts	Per port 48V DC, max. 35 watts
Power Pin Assignment	1/2 (+), 3/6 (-) 4/5 (+), 7/8 (-)	Port 1: 1/2 (+), 3/6 (-), 4/5(+), 7/8(-) Port 2~5: 1/2 (+), 3/6 (-)
PoE Power Budget	Maximum 65W (depending on power input)	Maximum 120W (depending on power input)

Standards Conformance	
Regulatory Compliance	FCC Part 15 Class A, CE
Standards Compliance	IEEE 802.3 10BASE-T Ethernet IEEE 802.3u 100BASE-TX Fast Ethernet IEEE 802.3ab 1000BASE-T Gigabit Ethernet IEEE 802.3z Gigabit SX/LX IEEE 802.3x Flow Control and Back Pressure IEEE 802.3af Power over Ethernet IEEE 802.3at Power over Ethernet Plus IEEE 802.3bt Power over Ethernet Plus
Environment	
Operating	Temperature: -20 ~ 65 degrees C Relative Humidity: 5 ~ 95% (non-condensing)
Storage	Temperature: -40 ~ 70 degrees C Relative Humidity: 5 ~ 95% (non-condensing)

2. Hardware Introduction

2.1 BSP-115HP-5A

2.1.1 BSP-115HP-5A Front Panel

The front panels of the Solar PoE Switches consist of Ethernet interfaces, LED indicators and DIP switch as shown below:

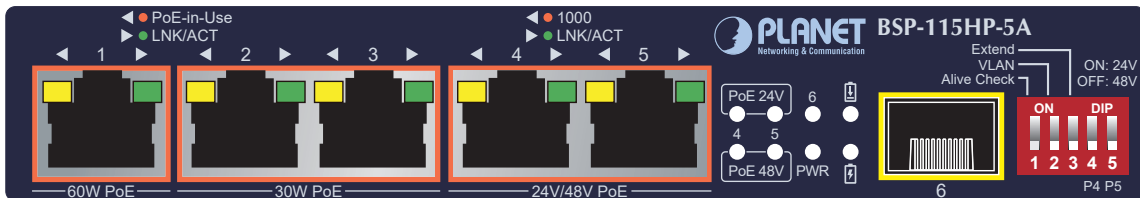

- **Gigabit TP Interfaces (Port 1 to Port 5)**
5 10/100/1000BASE-T RJ45 auto-MDI/MDI-X ports
- **Gigabit SFP Slot (Port 6)**
1 100/1000BASE-X SFP port
- **DIP Switch Definition:**

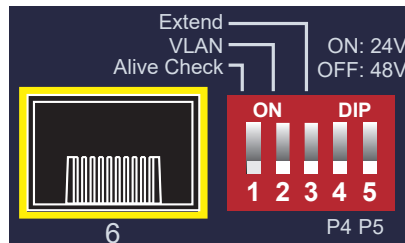

DIP Switch	Description
Alive Check:	PoE PD alive check switch
VLAN:	Port isolation
Extend:	Long-distance PoE switch
ON: 24V	4-5 port forced 24V power supply mode
OFF: 48V	4-5 port forced 48V power supply mode

2.1.2 BSP-115HP-5A Rear Panel

The rear panel of the Solar PoE Switch consists of one terminal block connector, rear system LED, DIP switch and temp. port as shown below:

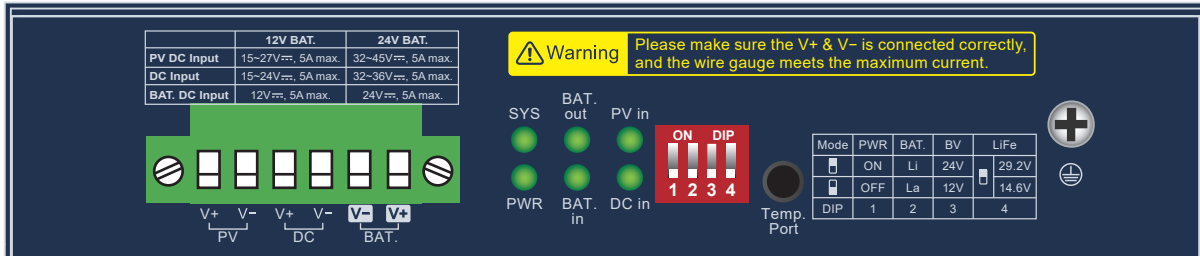

- **Terminal Block Definition:**

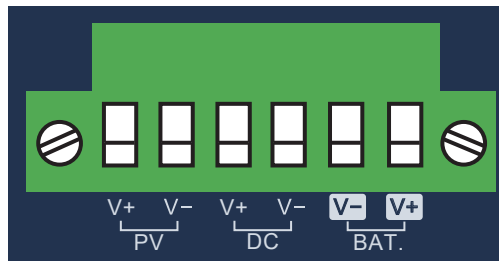

Location		Description
PV	V+	Solar cathode
	V-	Solar negative electrode
DC	V+	DC cathode
	V-	DC negative electrode
BAT.	V-	Battery negative electrode
	V+	Battery positive

● **BSP-115 Series Battery type Definition:**

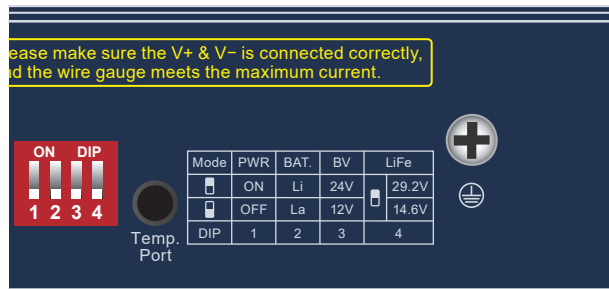

DIP switch	Description
1	Equipment power switch
2	Battery type switch
3	Battery voltage switch
4	Lithium iron phosphate switch

Battery type selection				
Switch 1	Switch 2	Switch 3	Switch 4	Description
ON: Equipment power ON	OFF	OFF	--	12V lead acid battery
	OFF	ON	--	24V lead-acid battery pack
	ON	OFF	OFF	12.6V lithium battery pack
	ON	OFF	ON	14.6V lithium iron phosphate battery pack
	ON	ON	OFF	25.2V lithium battery pack
	ON	ON	ON	29.2V lithium iron phosphate battery pack
OFF	--	--	--	Equipment power OFF

● **BSP-115 Series Temp. Port**

Location	Description
Temp. Port	Battery temperature and humidity sensor input port Battery temperature sensing range 70 ~ 75 degrees C



Temperature sensor



Note

The BSP-115HP-5A and BSP-115PV-15A use different temperature sensors and cannot be used interchangeably, If used incorrectly, the temperature value will not be read and the battery protection mechanism will not be activated.

2.1.3 BSP-115HP-5A LED Definition

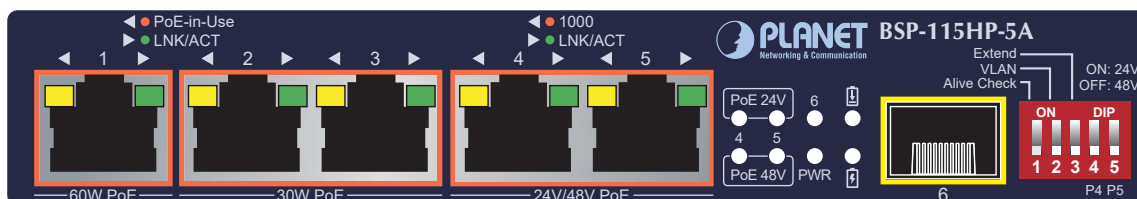

● 10/100/1000T RJ45 PoE+ Ports (Port 1 to Port 3)



LED	Color	Function	
10/100/1000 LNK/ACT	Green	Lights	To indicate the port is successfully established.
		Blinks	To indicate that the switch is actively sending or receiving data over that port.
PoE-in-Use	Amber	Lights	To indicate the port is providing DC in-line power.
		Off	To indicate the connected device is not a PoE PD.

● 10/100/1000T RJ45 PoE+ Ports (Port 4 to Port 5)

LED	Color	Function	
10/100 LNK/ACT	Green	Lights	To indicate the port is successfully established at 100Mbps or 10Mbps.
		Blinks	To indicate that the switch is actively sending or receiving data over that port.
1000	Amber	Lights	To indicate the port is successfully established at 1000Mbps.

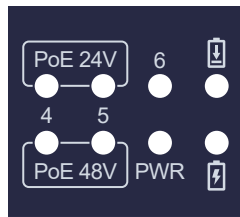
● **Front System LED Definition:**



Function indicator	Color	State	Description
PoE 24V	Green	Lights	To indicate the port is providing 24V DC in-line power.
		Off	To indicate the connected device is not a PoE PD.
PoE 48V	Green	Lights	To indicate the port is providing 48V DC in-line power.
		Off	To indicate the connected device is not a PoE PD.
6 Optical port: 6	Green	Lights	Optical network Linkup
		Off	Optical network down
		Blinks	To indicate that the switch is actively sending or receiving data over that port.
PWR Power indicator	Green	Lights	To indicate the system power works normally when the Alive Check is switched off.
		Blinks	To indicate the system power works normally when Alive Check is switched on.
		Off	The system power is off.
 Battery discharge indicator	Green	Always on	Battery discharge > 15%
		Always off	End of battery discharge or no discharge
		Blinks	Flashing every half-second, power<15%
 Charging indicator	Green	Always on	Charging and power <98%
		Always off	End of battery charging or no charging
		Blinks	It is about to be fully charged, and the power is = 98%.

● **BSP-115 Series Rear System LED Definition:**

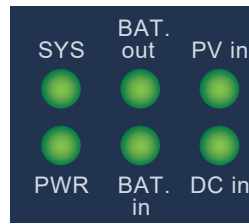

Function indicator (rear)	Color	State	Description
SYS: System operation indicator	Green	Lights	The system has power but is not functioning properly.
		Off	The system did not start successfully.
		Blinks	Flashing every half-second indicates that the battery is normal. Flashing every quarter-second indicates battery failure.
PWR: Power board voltage OK indicator	Green	Lights	Power board voltage is normal.
		Off	Power board voltage is abnormal.
BAT. out: Discharge indicator	Green	Lights	Battery discharge >15%
		Off	End of battery discharge or no discharge
		Blinks	Flashing every half-second, power <15%
BAT. in: Charging indicator	Green	Lights	Charging and power <98%
		Off	End of battery charging or no charging
		Blinks	When the battery is charged or not charged, it will be fully charged, and the power is = 98%.
PV in: Solar energy input indicator	Green	Lights	The solar energy input is normal.
		Off	Solar energy not input
		Blinks	When flashing every half-second, it indicates that the solar energy is in delayed charging with a duration of 10 minutes. When flashing every quarter-second, it indicates that the solar energy input voltage is wrong and the charging is stopped.
DC in: DC input indicator	Green	Lights	DC input normal
		Off	DC not input
		Blinks	DC input voltage error, stop charging

2.2 BSP-115PV-15A

2.2.1 BSP-115PV-15A Front Panel

The front panel of the Solar PoE Switch consists of Ethernet interfaces, LED indicators and DIP Switch as shown below:



- **Gigabit TP Interfaces (Port 1 to Port 5)**
5 10/100/1000BASE-T RJ45 auto-MDI/MDI-X ports
- **Gigabit SFP Slot (Port 6)**
1 100/1000BASE-X SFP port
- **DIP Switch Definition:**

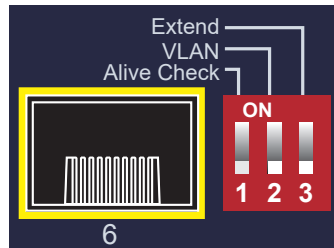

DIP Switch	Description
Alive Check	PoE PD alive check switch
VLAN	Port isolation
Extend	Long distance PoE switch

2.2.2 BSP-115PV-15A Rear Panel

The rear panel of the Solar PoE Switch consists of one terminal block connector, rear system LED, DIP switch and temp. port as shown below:

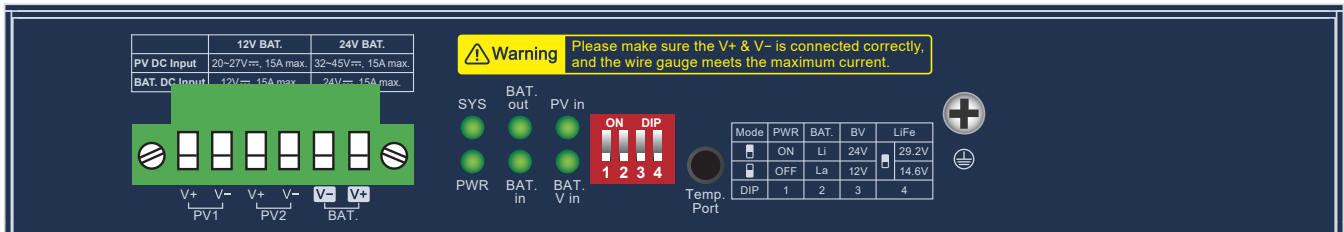

● Terminal Block Definition:

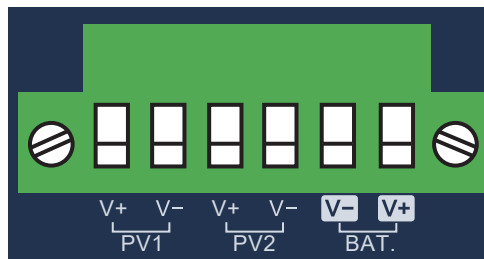

Location		Description
PV1	V+	Solar cathode
	V-	Solar negative electrode
PV2	V+	Solar cathode
	V-	Solar negative electrode
BAT.	V-	Battery negative electrode
	V+	Battery positive

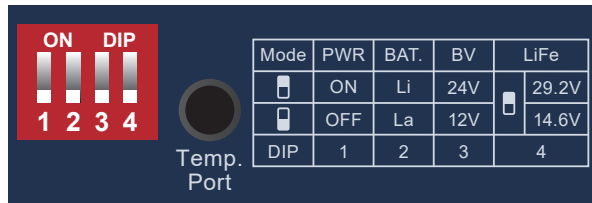

DIP switch	Description
1	Equipment power switch
2	Battery type switch
3	Battery voltage switch
4	Lithium iron phosphate switch

Battery type selection				
Switch 1	Switch 2	Switch 3	Switch 4	Description
ON: Equipment power ON	OFF	OFF	--	12V lead acid battery
	OFF	ON	--	24V lead-acid battery pack
	ON	OFF	OFF	12.6V lithium battery pack
	ON	OFF	ON	14.6V lithium iron phosphate battery pack
	ON	ON	OFF	25.2V lithium battery pack
	ON	ON	ON	29.2V lithium iron phosphate battery pack
OFF	--	--	--	Equipment power OFF

2.2.3 BSP-115PV-15A LED Definition:

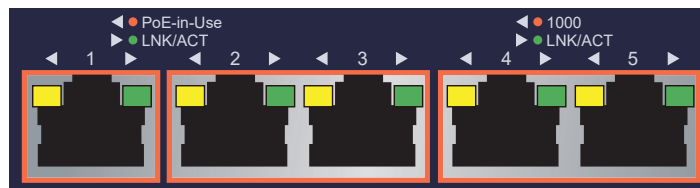

- **10/100/1000T RJ45 PoE+ Ports (Port 1 to Port 3)**



LED	Color	Function	
10/100/1000 LNK/ACT	Green	Lights	To indicate the port is successfully established.
		Blinks	To indicate that the switch is actively sending or receiving data over that port.
PoE-in-Use	Amber	Lights	To indicate the port is providing DC in-line power.
		Off	To indicate the connected device is not a PoE PD.

- **10/100/1000T RJ45 PoE+ Ports (Port 4 to Port 5)**

LED	Color	Function	
10/100 LNK/ACT	Green	Lights	To indicate the port is successfully established at 100Mbps or 10Mbps.
		Blinks	To indicate that the switch is actively sending or receiving data over that port.
1000	Amber	Lights	To indicate the port is successfully established at 1000Mbps.

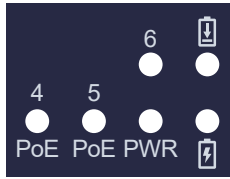
Front System LED Definition:



Function indicator	Color	State	Description
PoE 4, 5	Green	Lights	To indicate the port is providing DC in-line power.
		Off	To indicate the connected device is not a PoE PD.
6 Optical port: 6	Green	Lights	Optical network Linkup
		Off	Optical network down
		Blinks	To indicate that the switch is actively sending or receiving data over that port.
PWR Power indicator	Green	Lights	To indicate the system power works normally when Alive Check is switched off.
		Blinks	To indicate the system power works normally when Alive Check is switched on.
		Off	The system power is off.
 Battery discharge indicator	Green	Lights	Battery discharge > 15%
		Off	End of battery discharge or no discharge
		Blinks	Power <15%
 Charging indicator	Green	Lights	Charging and power <98%
		Off	End of battery charging or no charging
		Blinks	It is about to be fully charged, and the power is = 98%.

BSP-115PV-15A Rear System LED Definition:

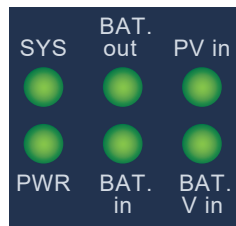

Function indicator (rear)	Color	State	Description
SYS: System operation indicator	Green	Lights	The system has power but is not functioning properly.
		Off	The system did not start successfully.
		Blinks	Flashing every half-second indicates that the battery is normal. Flashing every quarter-second indicates battery failure.
PWR: Power board voltage OK indicator	Green	Lights	Power board voltage is normal.
		Off	Power board voltage is abnormal.
BAT. out: Discharge indicator	Green	Lights	Battery discharge >15%
		Off	End of battery discharge or no discharge
		Blinks	Flashing every half-second, power<15%
BAT. in: Charging indicator	Green	Lights	Charging and power <98%
		Off	End of battery charging or no charging
		Blinks	When the battery is charged or not charged, it will be fully charged, and the power is = 98%.
PV in: Solar energy input indicator	Green	Lights	The solar energy input is normal.
		Off	Solar energy not input
		Blinks	When flashing every half-second, it indicates that the solar energy is in delayed charging with a duration of 10 minutes. When flashing every quarter-second, it indicates that the solar energy input voltage is wrong and the charging is stopped.
BAT. V in: DC input indicator	Green	Lights	Battery Voltage input normal
		Blinks	When flashing every quarter-second, it indicates abnormal input voltage. When flashing every half-second, it indicates a low current power supply.

2.3 Wiring the Power Inputs

The 6-contact terminal block connector on the rear panel of Solar PoE Switch is used for PV power input, DC power input and BAT power input. Please follow the steps below to insert the power wire.



Caution

When performing any of the procedures like inserting the wires or tightening the wire-clamp screws, make sure the power is OFF to prevent from getting an electric shock.

For BSP-115HP-5A

1. Insert positive and negative PV power wires into Contacts 1(V+) and 2(V-), DC power wires into Contacts 3(V+) and 4(V-), Contacts 5(V-) and 6(V+) for BAT power input.

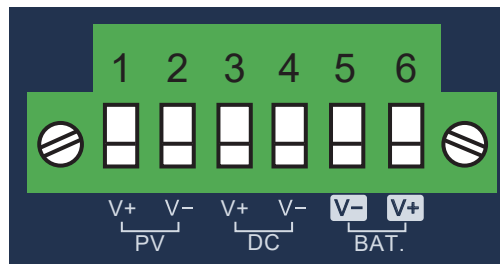

2. The input voltage range of each interface is shown as follows:

BSP-115HP-5A Power Requirements:

	12V BAT.	24V BAT.
PV DC Input	15~27V $\overline{=}$, 5A max.	32~45V $\overline{=}$, 5A max.
DC Input	15~24V $\overline{=}$, 5A max.	32~36V $\overline{=}$, 5A max.
BAT. DC Input	12V $\overline{=}$, 5A max.	24V $\overline{=}$, 5A max.

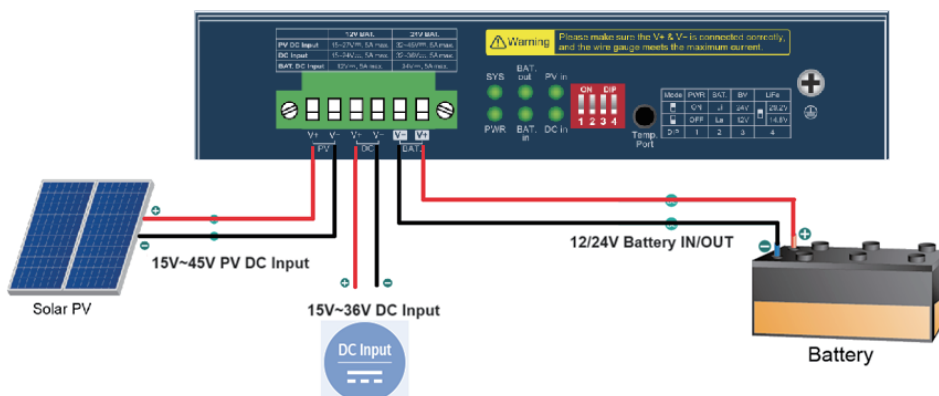

For BSP-115PV-15A

3. Insert positive and negative PV1 power wires into Contacts 1(V+) and 2(V-); PV2 power wires into Contacts 3(V+) and 4(V-), and Contacts 5(V-) and 6(V+) for BAT power input.

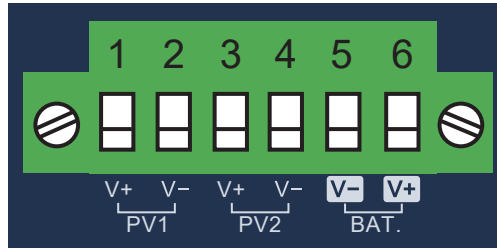

4. The input voltage range of each interface is shown as follows:

BSP-115PV-15A Power Requirements:

	12V BAT.	24V BAT.
PV DC Input	20~27V $\overline{=}$, 15A max.	32~45V $\overline{=}$, 15A max.
BAT. DC Input	12V $\overline{=}$, 15A max.	24V $\overline{=}$, 15A max.

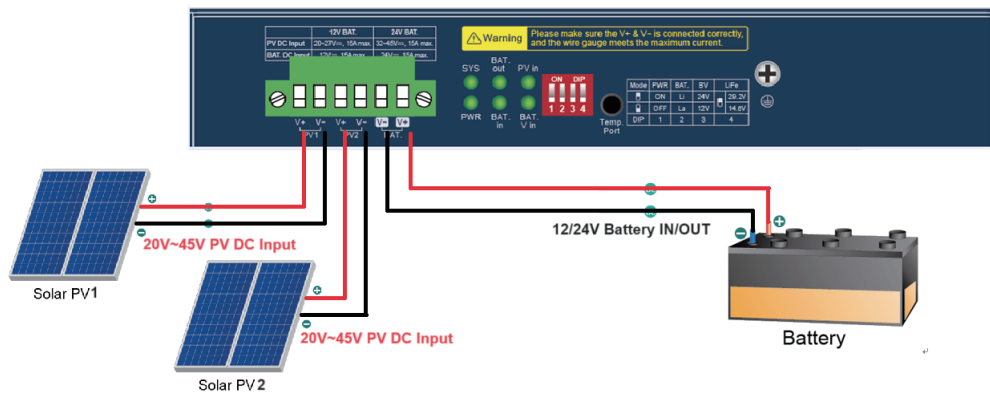

5. Tighten the wire-clamp screws for preventing the wires from loosening.

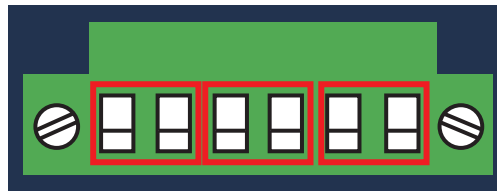

Note

1. The wire gauge for the terminal block should be in the range between 12 and 24 AWG.
2. The **BSP-115 Series** supports a maximum power input of 45V. To avoid damage, please use the **BSP-115 Series** under its specifications.

2.4 Grounding the Device

Users **MUST** complete grounding wired with the device; otherwise, a sudden lightning could cause fatal damage to the device.

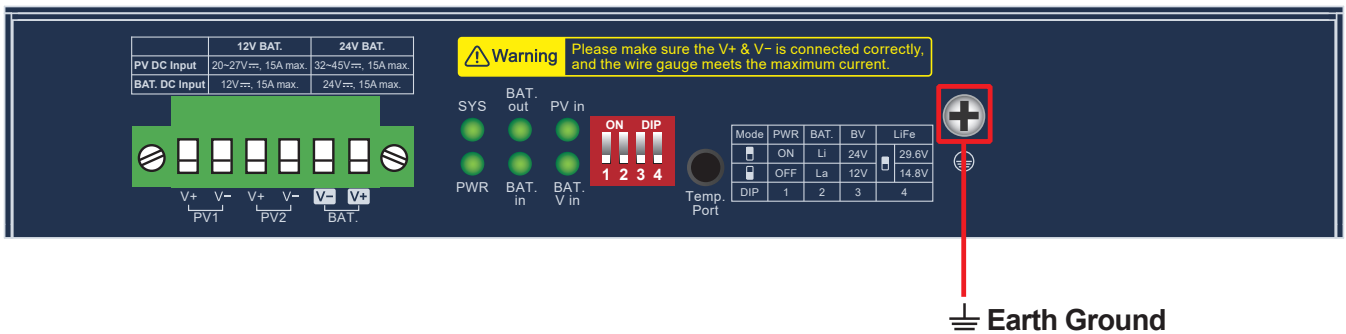

Note

EMD (Lightning) DAMAGE IS NOT COVERED UNDER WARRANTY.

3. Installation

This section describes the functionalities of the Solar PoE Switch's components and guides you to installing it. Basic knowledge of networking is assumed. Please read this chapter completely before continuing.



Note

The installation procedures of the BSP-115HP-5A and BSP-115PV-15A are the same as those shown below.

3.1 Wall-mount Plate Mounting

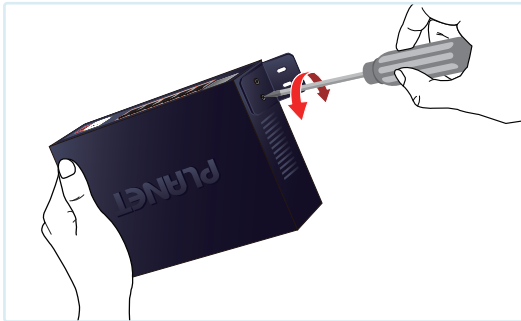

Caution

You must use the screws supplied with the wall-mounting brackets. Damage caused to the parts by using incorrect screws would invalidate your warranty.

3.2 Hardware Installation

The following section describes the hardware installation of the BSP-115 series. Before connecting any network device to the BSP-115, read this chapter carefully.

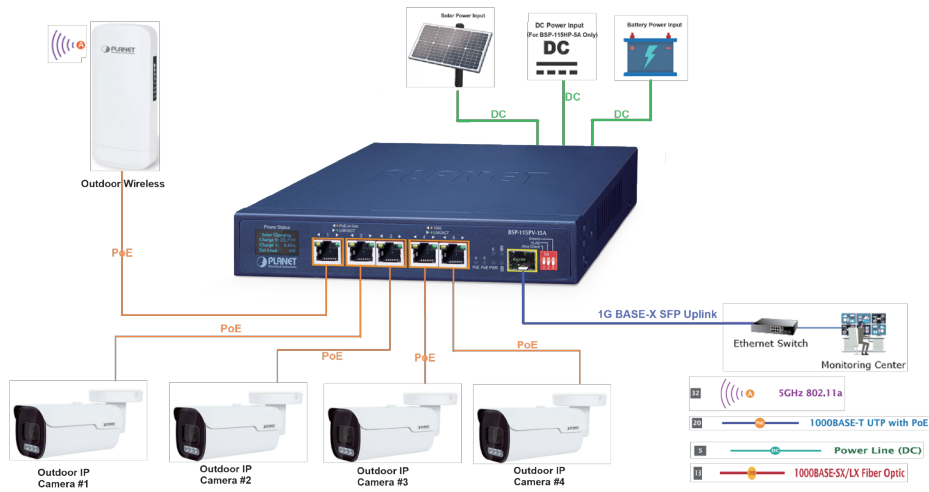

Please follow the following steps to install the system:

3.3 Installing the Solar PoE Switch

Place the Solar PoE Switch in a desired location using the Desktop or wall-mount fixtures.

Note

1. Please install the Solar PoE Switch in a proper enclosure or shelter.
2. The Solar PoE Switch must be grounded.

3.4 Installing Battery

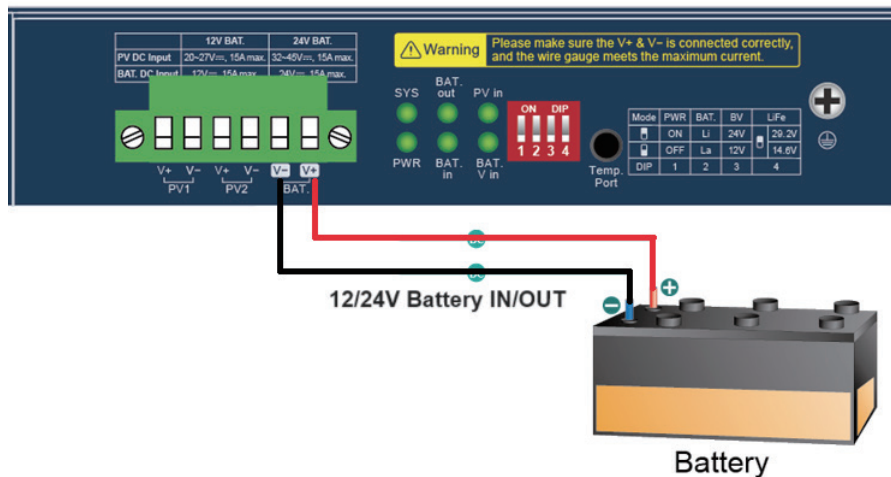

- (1) Connect the **negative electrode of the battery** to the terminal for the **negative electrode of the battery** on the Solar PoE Switch. By default, the lithium battery is in use.
- (2) Connect the **positive electrode of the battery** to the terminal for the **positive electrode of the battery** on the Solar PoE Switch.
- (3) Setting the battery type in the DIP switch.

BSP-115 Series Battery type Definition:

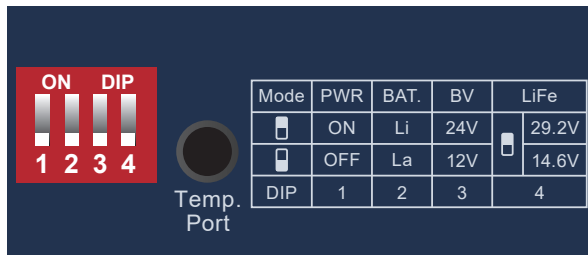

DIP switch	Description
1	Equipment power switch
2	Battery type switch
3	Battery voltage switch
4	Lithium iron phosphate switch

Battery type selection				
Switch 1	Switch 2	Switch 3	Switch 4	Description
ON: Equipment power ON	OFF	OFF	--	12V lead-acid battery
	OFF	ON	--	24V lead-acid battery pack
	ON	OFF	OFF	12.6V lithium battery pack
	ON	OFF	ON	14.6V lithium iron phosphate battery pack
	ON	ON	OFF	25.2V lithium battery pack
	ON	ON	ON	29.2V lithium iron phosphate battery pack
OFF	--	--	--	Equipment power OFF



Caution

1. The BSP-115 Solar PoE Switch Series accepts the **12V and 24V DC** battery. Please pay attention to the battery characteristics and also refer to the **“BSP-115 series battery type definition”** to set the rear DIP switch.
2. Check the total power consumption of your connected network device before installation. Improper battery capacity could shorten the battery life or make your network device lack of power supply.



Note

Be noted for the thickness of electric wire and please refer to the section **“Recommended Use of the Connected Wires”** in the Quick Installation Guide.

3.5 Installing PV Panel

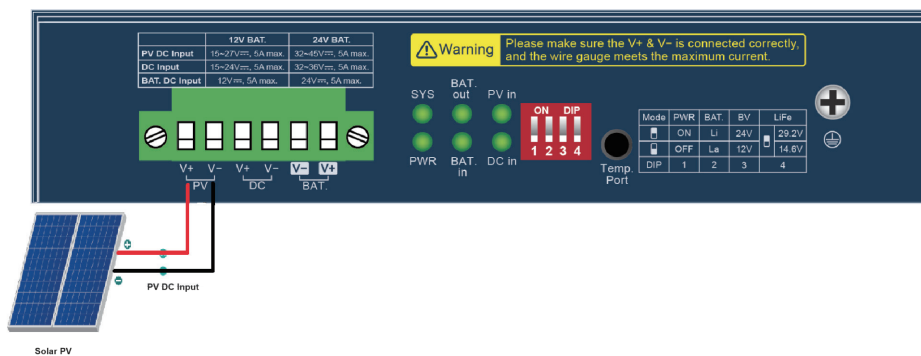

BSP-115HP-5A PV Input

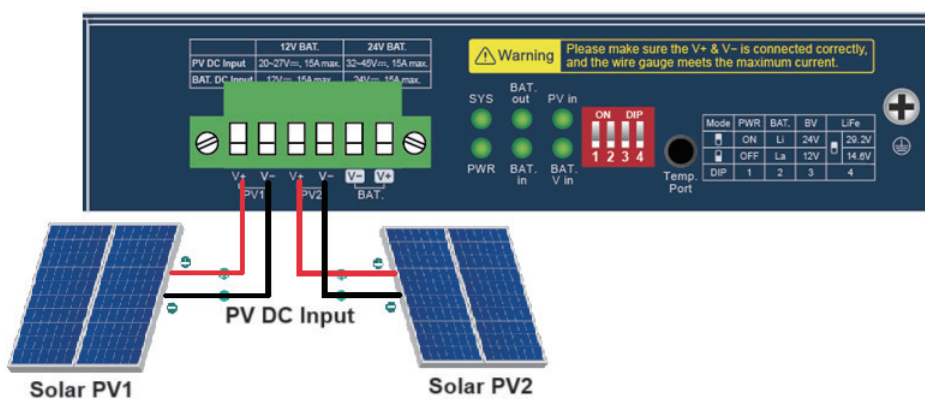

BSP-115PV-15A PV Input

- (1) Connect the **negative electrode of the PV panel** to the terminal for the **negative electrode of the PV panel** on the Solar PoE Switch.
- (2) Connect the **positive electrode of the PV panel** to the terminal for the **positive electrode of the PV panel** on the Solar PoE Switch.



Note

1. Be noted for the thickness of electric wire and please refer to the section **“Recommended Use of the Connected Wires”** in the Quick Installation Guide.
2. Check the total power consumption of your device and the sunshine duration of your area from the weather bureau for a proper PV. Improper PV could shorten the battery life or provide insufficient power to the Solar PoE Switch.

3.6 Installing DC Power

For **BSP-115HP-5A** only

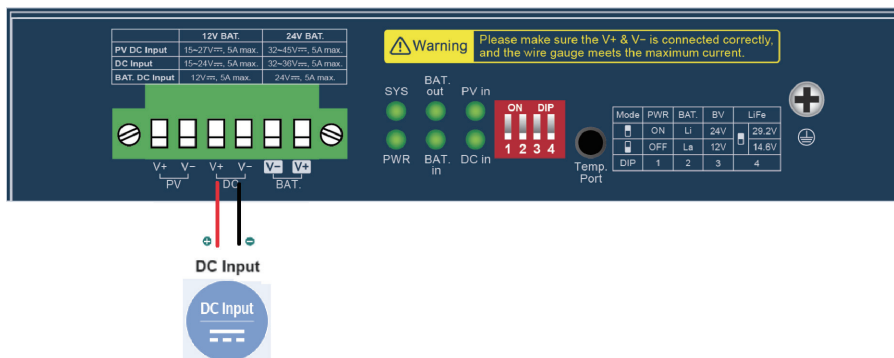

BSP-115HP-5A DC Input

- (1) Connect the **negative electrode of the DC Power** to the terminal for the **negative electrode of the DC Input** on the Solar PoE Switch.
- (2) Connect the **positive electrode of the DC Power** to the terminal for the **positive electrode of the DC Input** for the Solar PoE Switch.





Note

Be noted for the thickness of electric wire and please refer to the section **“Recommended Use of the Connected Wires”** in the Quick Installation Guide.

4. Smart LCD Screen Description

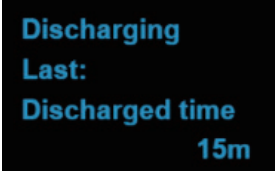
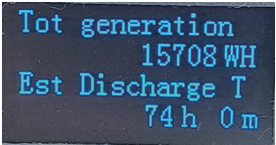
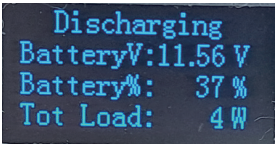
4.1 Smart LCD screen description (BSP-115PV-15A only):

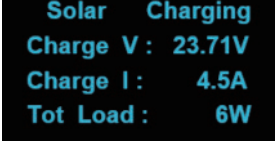
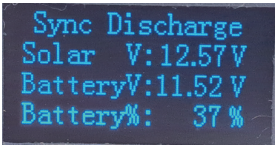
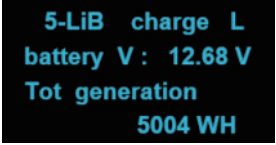
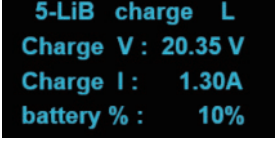
NO	Screen	Description
1		Battery powered Battery life: The battery has been powered for 15 minutes.
2		Total power generation 15708WH Estimated power supply time: 74 hours and 0 minutes (will vary depending on load)
3		Battery status Current battery voltage: 11.56V Current battery level: 37% Current total output power consumption: 4%
4		Solar startup Required for system operation: 1.09V Solar current voltage: 25.80V 4 LiB scratchpad
5		solar charging Charging voltage: 23.71V Charging one: 4.5A Current total load: 6W
6		Synchronized discharge Solar current voltage: 12.57V Current battery voltage: 11.52V Current battery charge percentage: 37%
7		14.6V lithium iron battery charging voltage L Current battery voltage: 12.68V Enter the total power generation of the battery 5004WH
8		14.6V lithium iron battery charging voltage L Charging voltage: 20.35V Charging one: 1.3A Current battery charge percentage: 10%

9		<p>Estimated discharge time 40m Total power generation 697WH</p>
10		<p>Total input power 149W Total power generation 699WH</p>
11		<p>Total power Solar power: 0W Battery power: 5W Total load: 4W</p>
12		<p>Environment (Needs BSP-115PV-15A sensor) Ambient temperature 39 Ambient humidity 21%</p>
13		<p>Discharge ends Battery voltage: 10.15V Discharge time 2m</p>

5. Customer Support

Thank you for purchasing PLANET products. You can browse our online FAQ resource at the PLANET Web site first to check if it could solve your issue. If you need more support information, please contact PLANET support team.

PLANET online FAQs:

<https://www.planet.com.tw/en/support/faq>

Support team mail address:

support@planet.com.tw

Copyright © PLANET Technology Corp. 2024.

Contents are subject to revision without prior notice.

PLANET is a registered trademark of PLANET Technology Corp.

All other trademarks belong to their respective owners.

Appendix A: Recommended Use of the Connected Wires

The wire gauges for the current are shown below:

Gauge	Diameter	Amp
AWG #16	1.295	10.00
AWG #17	1.143	8.40
AWG #18	1.016	6.40
AWG #19	0.914	5.20
AWG #20	0.813	4.00

FCC Warning

This device has been tested and found to comply with the limits for a Class A digital device, pursuant to Part 15 of the FCC Rules. These limits are designed to provide reasonable protection against harmful interference when the equipment is operated in a commercial environment. This equipment generates, uses, and can radiate radio frequency energy and, if not installed and used in accordance with the Instruction manual, may cause harmful interference to radio communications. Operation of this equipment in a residential area is likely to cause harmful interference in which case the user will be required to correct the interference at his own expense.

CE Mark Warning

This equipment is compliant with Class A of CISPR 32. In a residential environment this equipment may cause radio interference.

WEEE Warning



To avoid the potential effects on the environment and human health as a result of the presence of hazardous substances in electrical and electronic equipment, end users of electrical and electronic equipment should understand the meaning of the crossed-out wheeled bin symbol. Do not dispose of WEEE as unsorted municipal waste and have to collect such WEEE separately.